

Memento

Cahier technique

TATOU BOIS

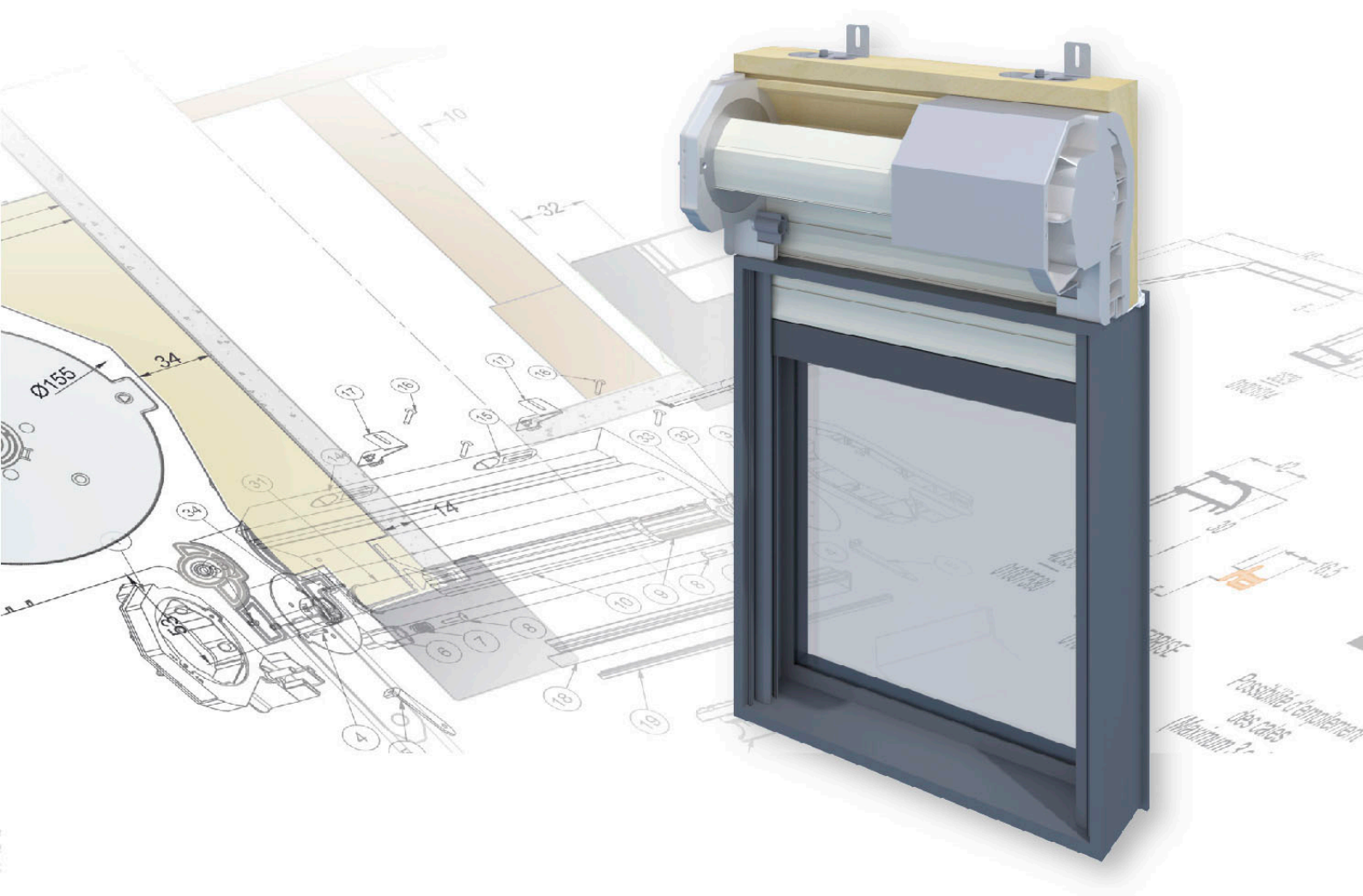

Vous accompagne dans la pose et la mise en service de vos produits Eveno

EVENO

Les éléments de votre Confort

Sommaire



TATOU BOIS

PRÉSENTATION

- Page 4-5 | Nuancier
COULEURS
- Page 6-8 | Planches Schémas
TECHNIQUES
- Page 9-10 | Caractéristiques
TECHNIQUES
- Page 12-13 | Automatismes
COMMANDES
- Page 14 | Contact
SECTEURS COMMERCIAUX

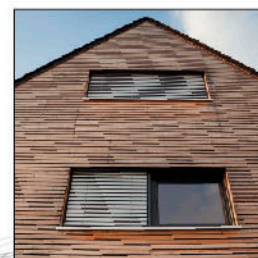
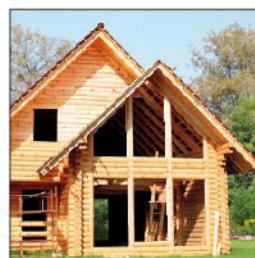
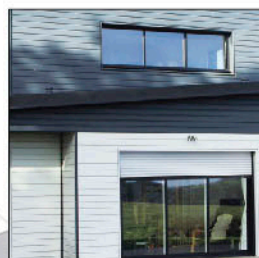
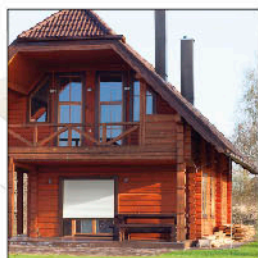
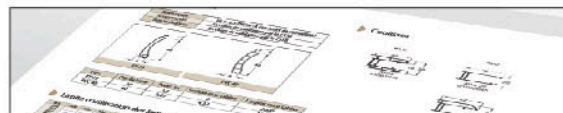
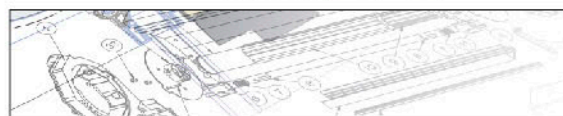

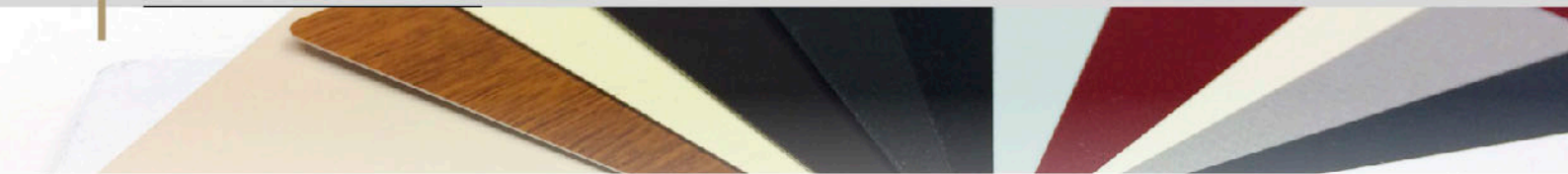

Tablier, coulisses et lame finale au prix du blanc

	Alu Ev 39	PVC 40	Coulisses Alu 40x22, 43x31	Coulisse PVC	Lame finale
Délai 1 semaine					
RAL 7016	●		●		●
RAL 9006 Aluminium	●		●		●
RAL 7035 Gris clair	●	●	●		●
RAL 8019	●		●		●
RAL 1015	●		●		●
Chêne doré	●		● *		●
Noir 2100 ⁽¹⁾ fine structure	●		●		●
Délai 2 semaines					
RAL 9005	●		●		●
Gregorex	●	●	●		●
RAL 3004	●		●		●

* Chêne doré uniquement disponible en coulisses 43x31, 53x22 et 53x22L60

⁽¹⁾ Fine structure = Ral Sablé ou texturé



La parfaite similitude entre des produits d'origine différente et de même teinte RAL ne peut être garantie (une tolérance étant admise par le standard RAL)

Tablier, coulisses et lame finale avec plus-value

Alu Ev 39 / Coulisses Alu 40x22, 43x31 / Lame finale

Délai **2 semaines**

Gris 2900 fine structure	●	●	●
RAL 8014	●	●	●
RAL 1013	●	●	●
RAL 7022	●	●	●
RAL 7015	●	●	●
RAL 7039	●	●	●
RAL 9007	●	●	●

Autres coloris, coulisses, lame finale et tablier

Coulisses	
Coulisses PVC la paire	Beige, gris teinté masse
	Plaxé Chêne doré
	Laquage autres RAL
Coulisses Alu la paire	Autres teintes RAL que celle au prix du blanc

Lame Finale
Autres teintes RAL que celles au prix du blanc

Nuancier BSO

Sans plus-value

Tabliers, coulisses et lame finale

Délai **3 semaines**

Blanc 9016	○
Gris Alu	●
RAL 1015	●
RAL 7016	●
RAL 8019	●
Noir 2100 fine structure	●

Délai **8 semaines**

RAL 9007	●
RAL 9005	●

Avec plus-value

Tabliers, coulisses et lame finale

Délai **8 semaines**

RAL 3003	●
RAL 3011	●
RAL 3013	●
RAL 5002	●
RAL 7022	●
RAL 1007	●
RAL 7035	●
RAL 5009	●
RAL 5014	●
RAL 5018	●

Délai **8 semaines**

RAL 6005	●
RAL 6021	●
RAL 1000	●
Bronze	●
RAL 7038	●
RAL 7039	●
RAL 9003	○
RAL 7037	●
RAL 9010	○
2900 fine structure	●

Tatou Bois

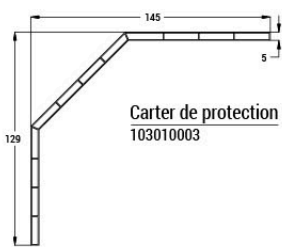
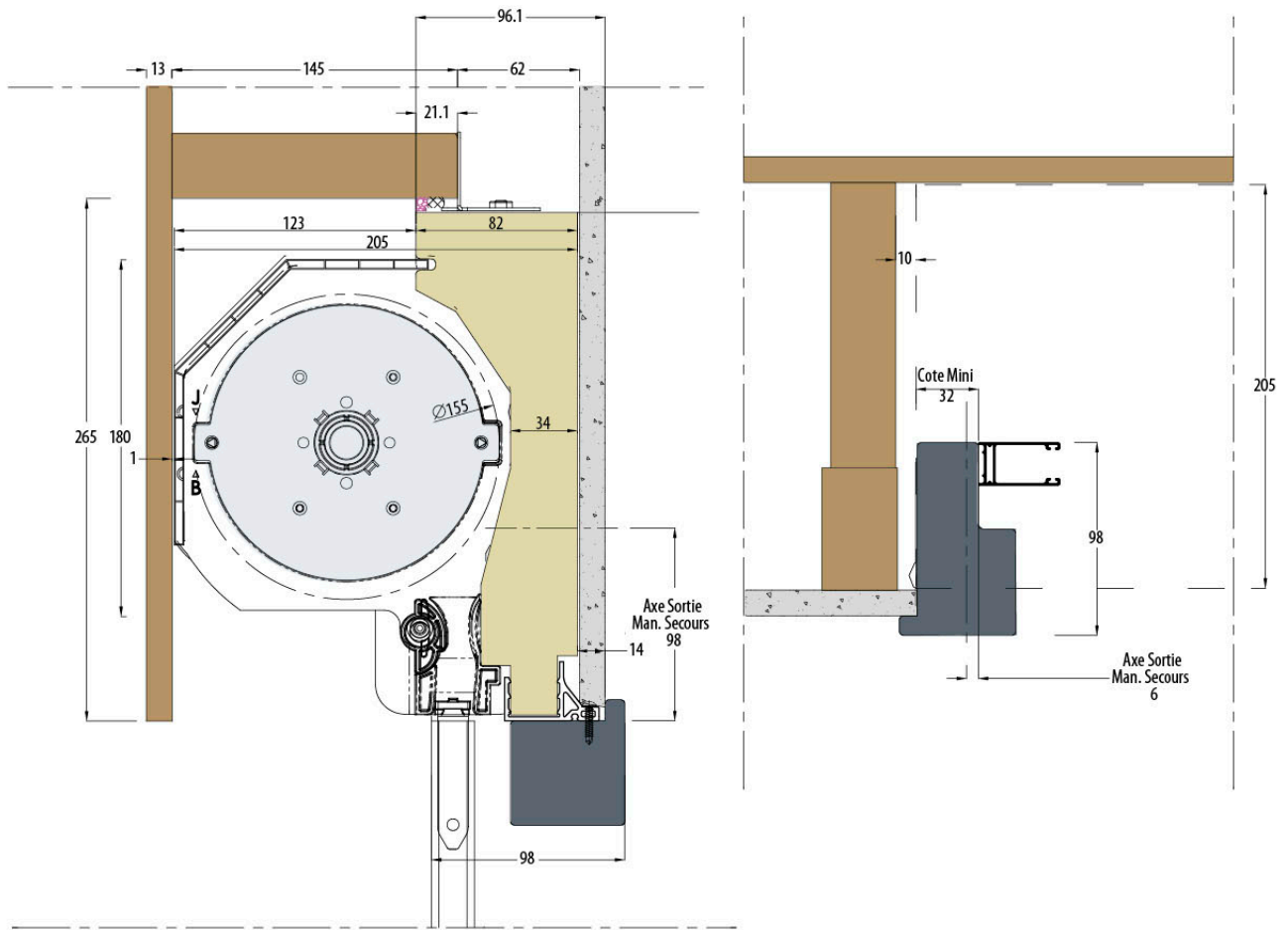

Coulisses PVC

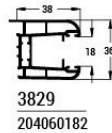

Coulisses Alu

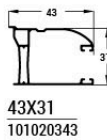
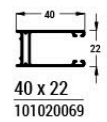

Accessoires

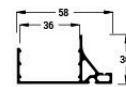

Profil de reprise
(pour Dormant >100)
103040026

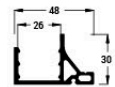

Profil de reprise
(pour Dormant 100)
103040025

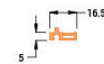

Cale de reprise
103040008



Possibilité d'empilement des cales
(Maximum 3 cales)

Montage moteur Axe diamètre 56

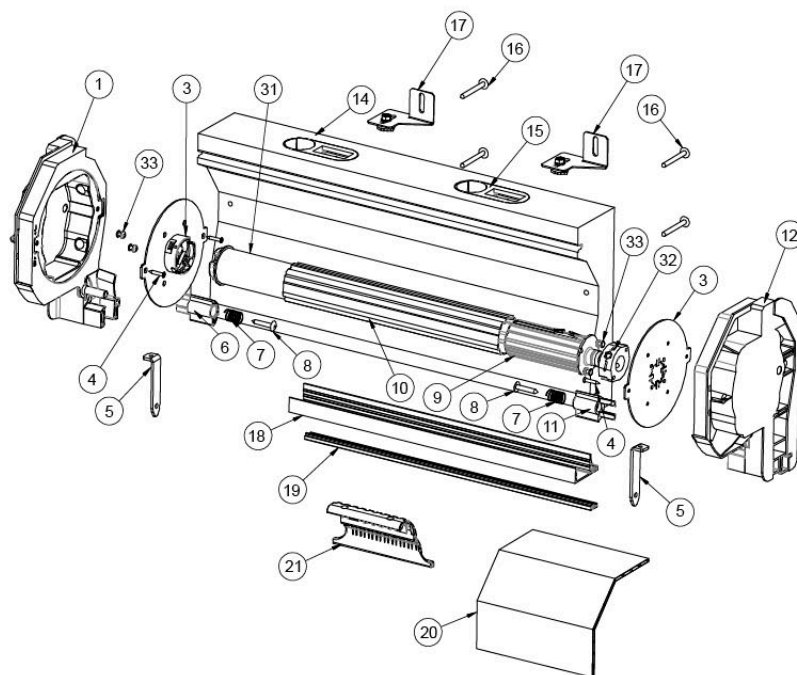

N°	Désignation	Code Article
1	Joue Droite	203010247
3	Flasque Tatou Bois	204010117
4	Vis 4,2 x25	203110003
5	Eclisse	204010021
6	Téton d'arrêt Droit	203010276
7	Ressort Téton	204010174
8	Vis penture 6x35 Zing	204110096
9	Embout ZF54 Escamotable	203060070
10	Axe diam 56 mm	104060003
11	Téton d'arrêt Gauche	203010277
12	Joue Gauche	203010250
14	Coque PU	110070013
15	Reprise Clameau	203010274
16	Vis Penture Fixation joue 6x60	204110109
17	Patte de reprise Linteau + Clameau	204010166
18	Profil reprise traverse haute	103040026
19	Cale profil reprise traverse haute	103040008
20	Carter Protection	103010003
21	Verrous	203060180
31	Moteur	
32	Palier Diam 22	203060122
33	Goupille Béta	204110010

Tatou Bois BSO

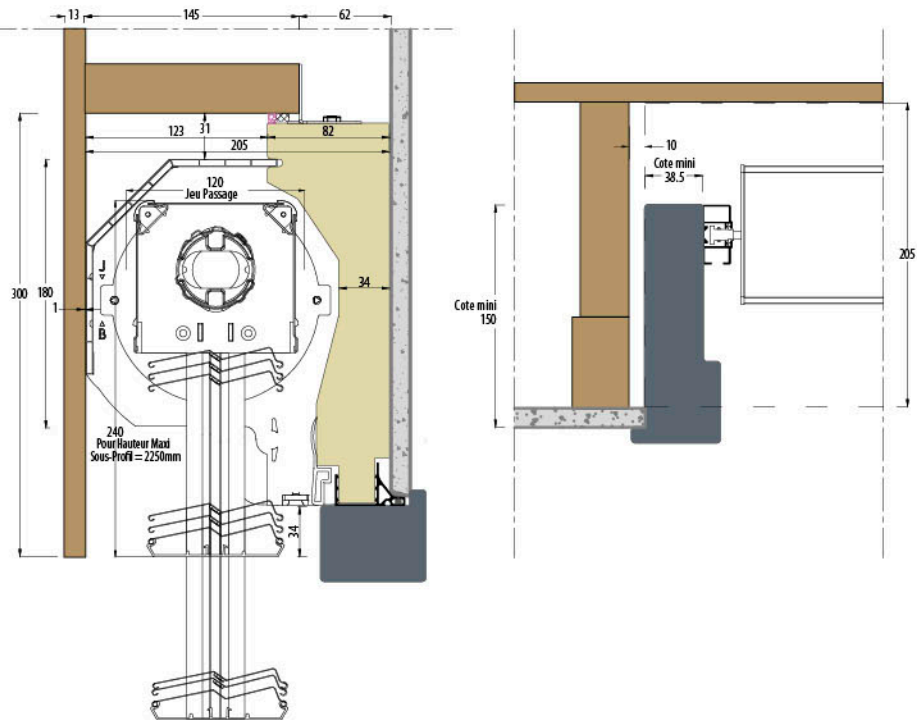

■ Dimensions maxi

Hauteur maxi = 2250 mm
 Largeur maxi = 3500 mm

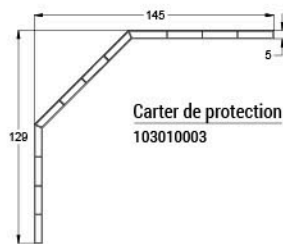

Coulisses Alu

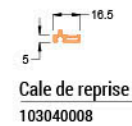
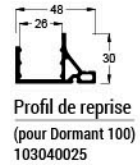
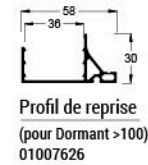

Tatou Bois ITE

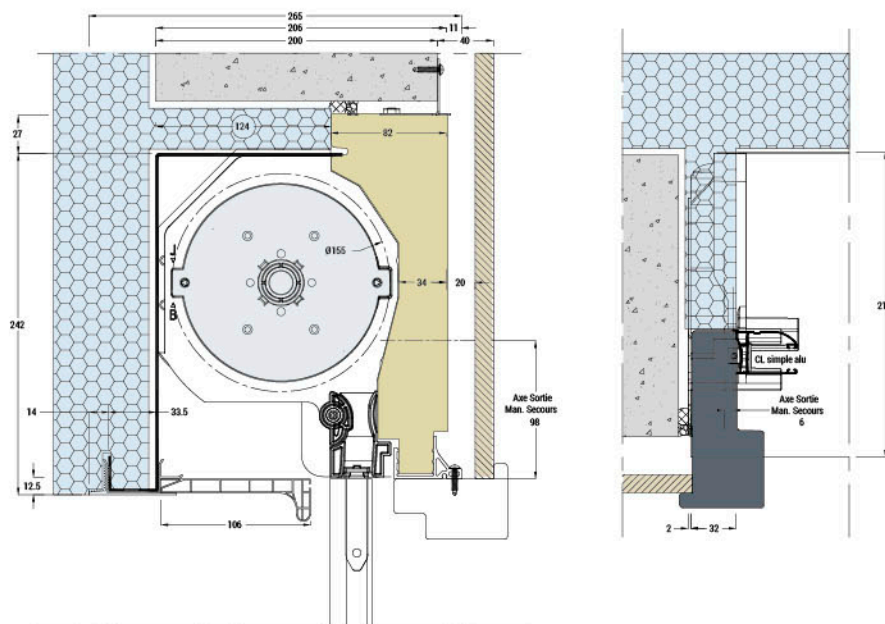

■ Lames

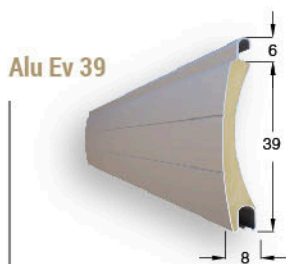

Alu Ev 39

Poids : 2,75 kg /m²
 Surface maxi tablier : 6 m²
 Largeur maxi tablier : 2800 mm
 $\Delta R = 0,18 \text{ m}^2 \cdot \text{K/W}^*$

*en TO et en moteur

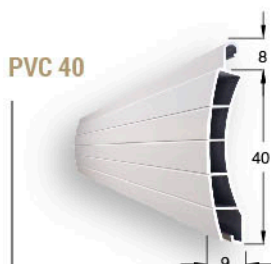

PVC 40

Poids : 3,07 kg /m²
 Surface maxi tablier : 4,32 m²
 Largeur maxi tablier : 1800 mm
 $\Delta R = 0,23 \text{ m}^2 \cdot \text{K/W}^*$

■ Cote enroulement

Axe 56	
Tabliers	Hauteur tableau
Alu Ev 39	2350
PVC 40	1600

■ Cotes mini dos de coulisses selon manœuvres

	TATOU BOIS*
Radio Zuni R	455
Radio Zigbee	455
Radio RS100	535
Radio IO	537
Filaire Simu	422
Manœuvre de secours Zuni R	579
Manœuvre de secours Simu	579

* Valeurs avec une coulisse Alu 43x31

■ Limite d'utilisation des lames

Alu Ev 39

H/L	500	600	700	800	900	1000	1100	1200	1300	1400	1500*	1600	1700	1800	1900	2000	2100	2200	2300	2400	2500	2600	2700	2800	
650																									
750																									
850																									
950																									
1050																									
1150																									
1250																									
1350																									
1450																									
1550																									
1650																									
1750																									
1850																									
1950																									
2050																									
2150																									
2250																									
2350																									

PVC 40

H/L	500	600	700	800	900	1000	1100	1200	1300	1400	1500	1600	1700	1800
650														
750														
850														
950														
1050														
1150														
1250														
1350														
1450														
1550														

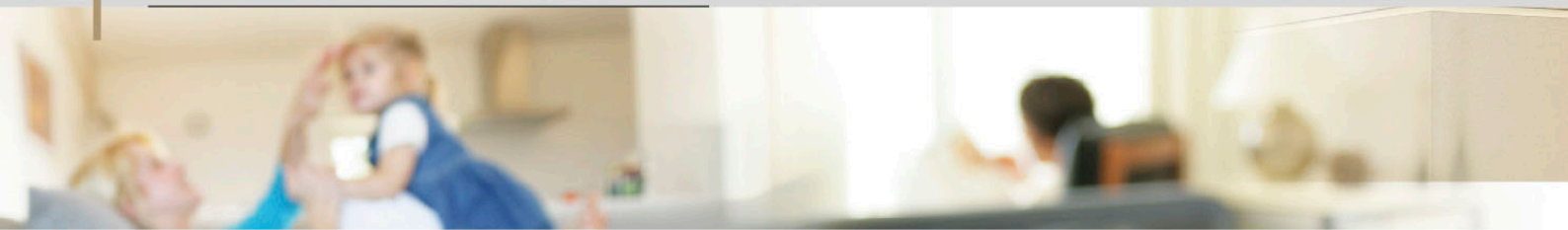

avec retour d'information

La motorisation radio ouverte à la maison intelligente d'aujourd'hui et de demain

Les commandes individuelles

Les commandes générales



Commande individuelle
portable radio



Commande individuelle
murale radio



Commande générale intuitive
avec retour d'information + 10 horloges



sans retour d'information

Le confort de la radio en toute simplicité

Les commandes individuelles



100% compatible,
idéal en rénovation
et complément de chantier



OPY
Commande individuelle
murale radio



UNO
Commande individuelle
portable radio



DOT
Inverseur filaire
intégrant un récepteur radio
Rend une installation filaire compatible
avec une installation radio
(sauf pour le Zuni R solaire)



Les commandes individuelles

Les commandes générales



Smoove
Sans retour
d'information



Situo IO 1
Sans retour
d'information



Situo IO 5
5 canaux



Nina
Création de
scénarios



Nina Timer
Création de scénarios
+ horloge

La box



Calyps'HOME

Box Calyps'home
connecte votre maison
à votre smartphone

Les compléments



Dongle
rend compatible
votre moteur ZigBee avec
l'univers Tahoma de Somfy
ou Tydom 1.0 de Delta Dore

Récepteur ZigBee
rend compatibles les équipements
annexes de votre maison
(PG, portail, BSO, lumières ...)

Les commandes générales



DUO
Commande générale
2 zones



NOÉ
Commande générale
portable 8 canaux
+ gestion horaire par horloge



TAO
Télécommande zuni®
qui à la fois pilote votre
porte de garage et ferme
tous vos volets roulants



Récepteur universel
Rend compatible votre
portail, quelle que soit
sa marque, avec
l'ensemble de la maison

Calyps'HOME



Dongle Zuni R
Rend compatible votre
moteur Zuni R avec la
box Calyps'home et la
box Tahoma V2 de Somfy

La box

Les compléments



Horloge 1 zone



Tahoma Box



Capteur solaire
compatible avec
la box Tahoma

Secteurs commerciaux **Fabricants de menuiserie**

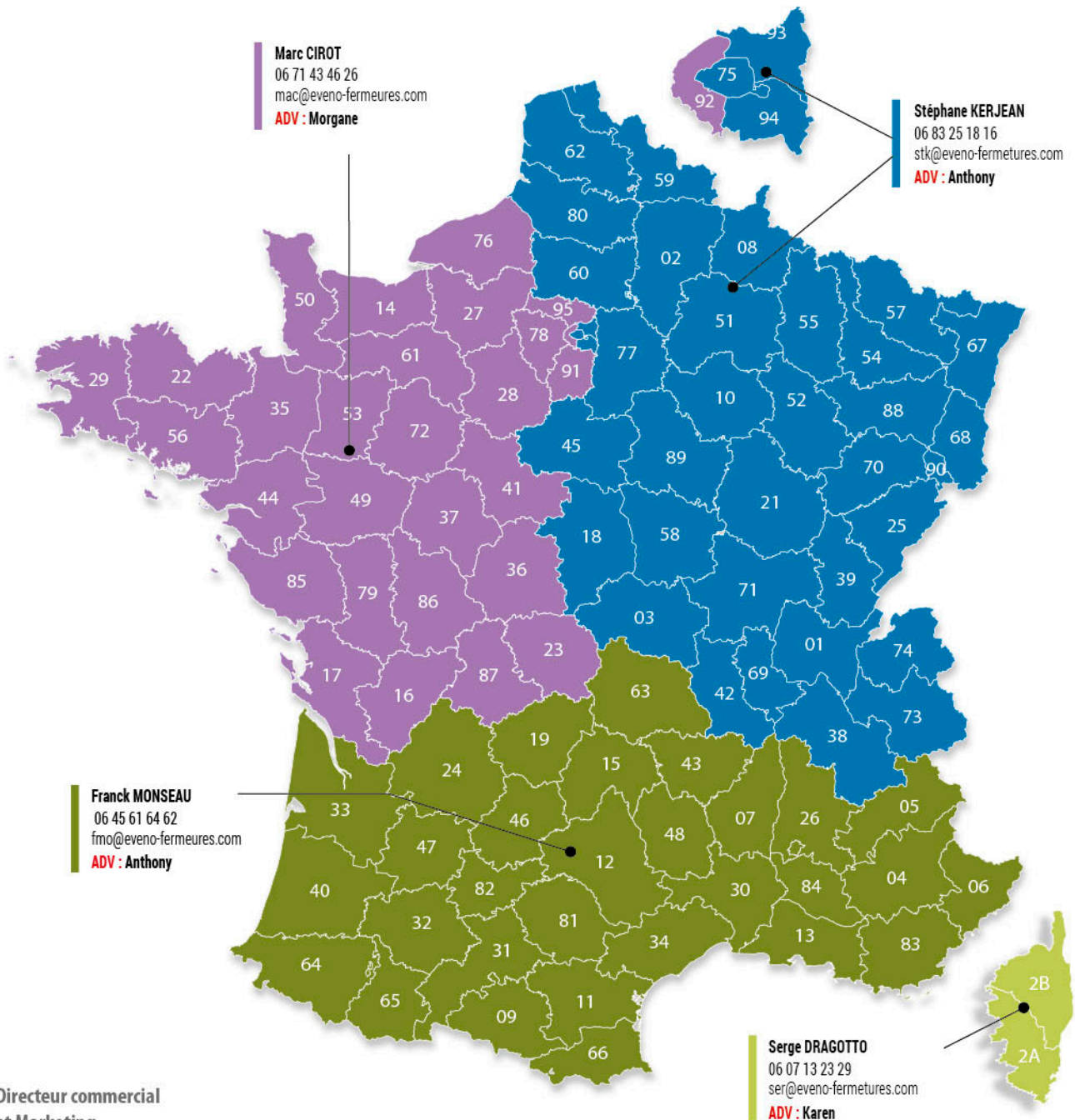

**Directeur commercial
et Marketing**
Stéphane VIGNAUD
stv@eveno-fermetures.com

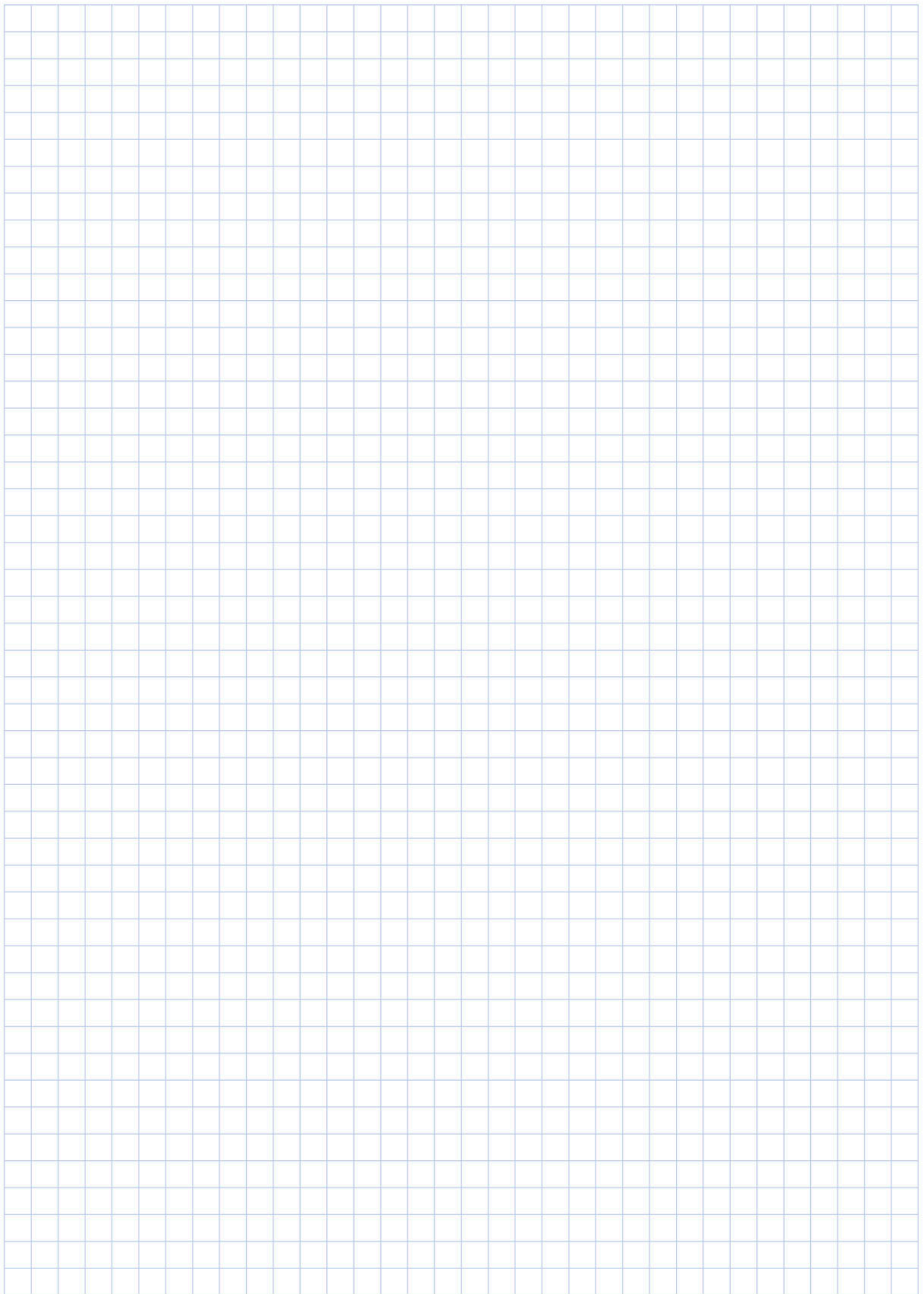

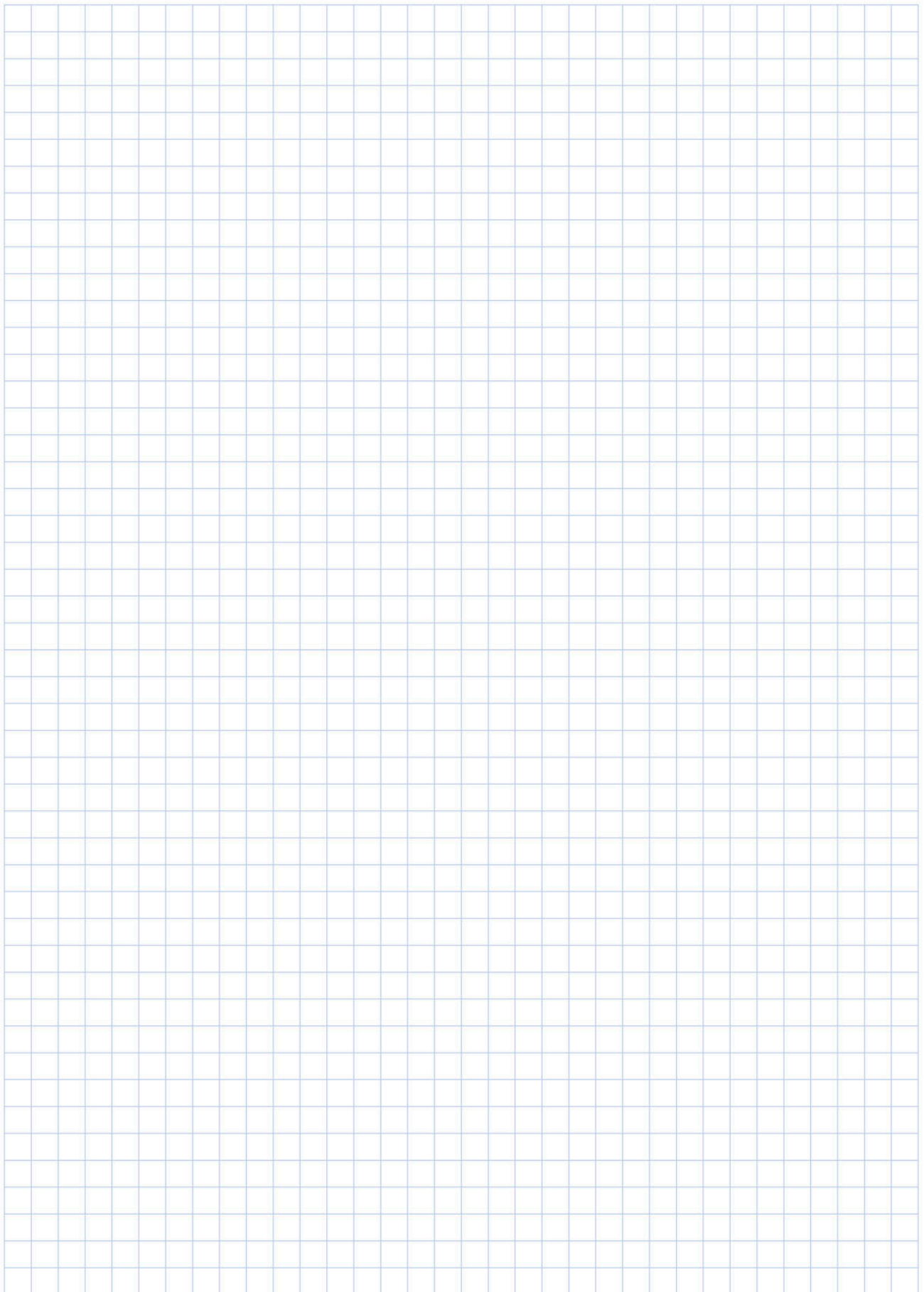

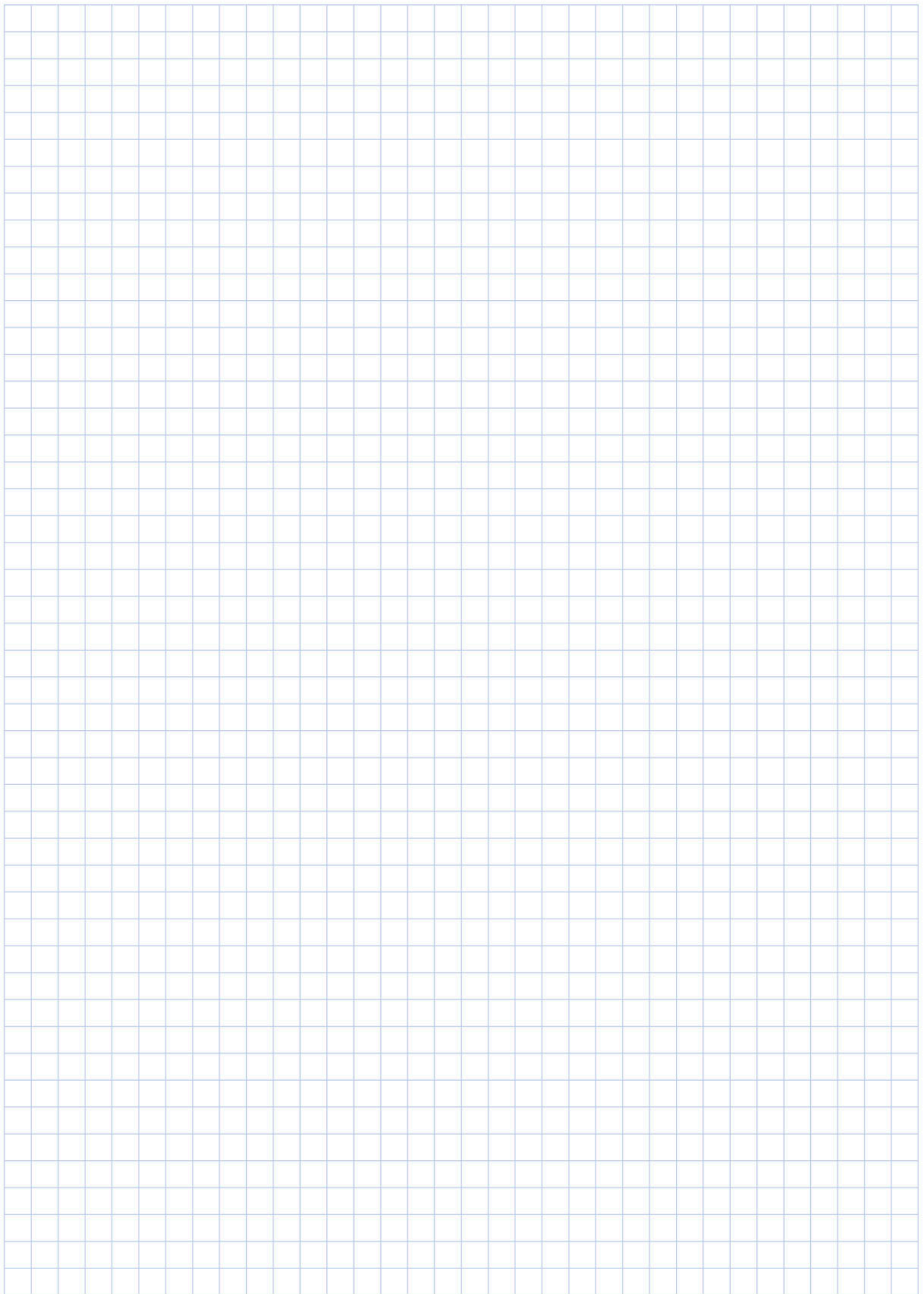

2019

Memento

Cahier technique

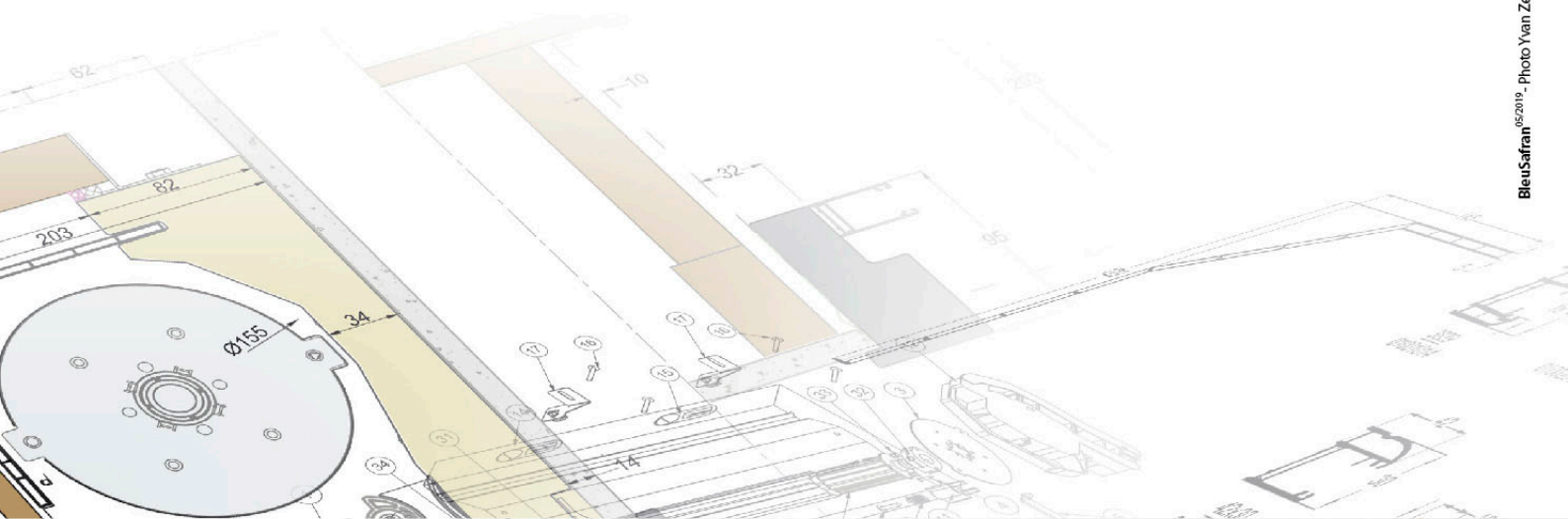

BleuSafran^{05/2019} - Photo Yan Zezda, Eveno images 3D Choe Production

EVENO

Les éléments de votre Confort



Eveno est sur [Twitter](#)

Z.I. du Gaillec - 56276 PLŒMEUR Cedex
contact@eveno-fermetures.com
www.eveno-fermetures.com

